

# Assembly Instructions

## Heavy-Duty, 2 Tier Table/Chair Dolly

Item 712TCC

### Required Tools

9/16" Wrench

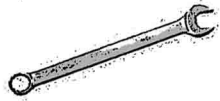

Adjustable Wrench



### Parts Listing

#### A - Upright Post

2 Pieces



#### B - Hanger Bar

1 Pieces



#### C - Cross Bar

2 Pieces



#### D - Base End Bar

2 Pieces



#### E - Hanger Arm

6 Pieces



#### FW - Fixed Wheel Assembly

2 Pieces



#### SW - Swivel Wheel Assembly w/Brake

2 Pieces



#### 3/8" x 2 1/2" Bolt

4 Pieces

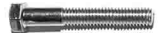

#### 3/8" x 2" Bolt

2 Pieces



#### 3/8" x 1 3/4" Bolt

18 Pieces

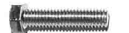

#### 3/8" x Hex Nut

24 Pieces



### Step 1

Attach an Upright Post (A) to a Base End Bar (D) using two 2 1/2" Bolts (up from the bottom) and one 2" Bolt (in from the outside).

Tighten all Hex Nuts securely.

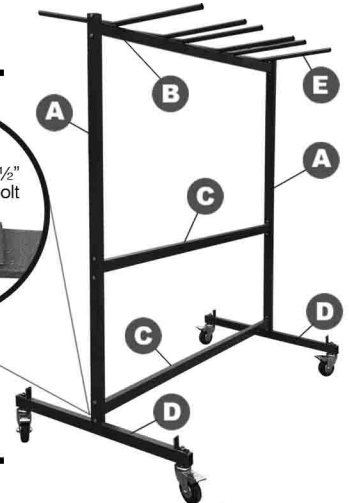
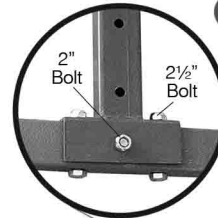
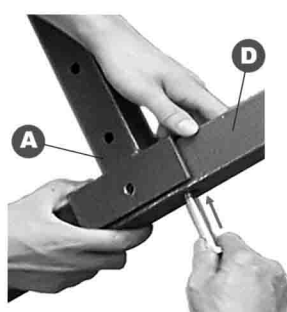

### Step 2

Attach Hanger Arms (E) to Hanger Bar (B) using the 1 3/4" Bolts.

Tighten all Hex Nuts securely.

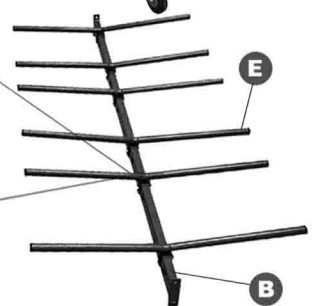
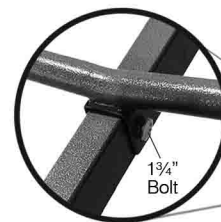

### Step 3

Attach Cross Bar (C) to the Base of the Uprights (A) using two 1 3/4" Bolts at each end.

Repeat Step 3 to connect the second Cross Bar (C) to the middle of the Upright Posts (A).

Tighten all Hex Nuts securely.

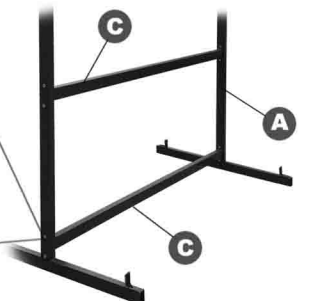
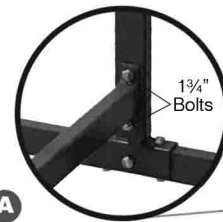
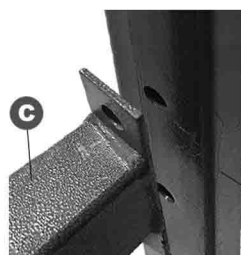

# Assembly Instructions (Continued)

## Heavy-Duty, 2 Tier Table/Chair Dolly

Item 712TCC

### Step 4

Connect assembled Hanger Bar (B) to the Uprights (A) using two 1 $\frac{3}{4}$ " Bolts at each end. Tighten all Hex Nuts securely.

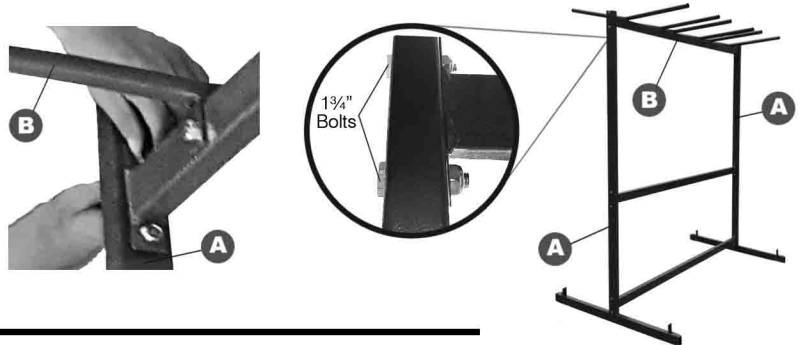

### Step 5

Insert both Fixed Wheel Assemblies (FW) into the bottom of the Base End Bar (D) and tighten Top Lock Nuts.

Then insert both Swivel Wheel Assemblies (SW) into the Base End Bar (D) and tighten Top Lock Nuts.

*Note: Keep Swivel Wheels in locked position during assembly.*

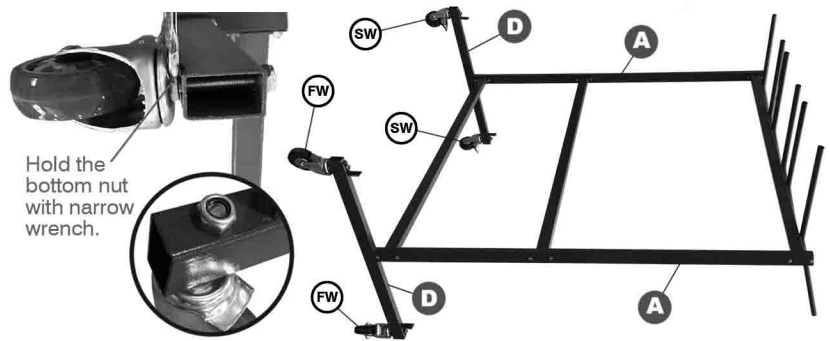

### Step 6

Turn completed Dolly upright. *This should be a two person job.*

**IMPORTANT:** Be sure the Swivel Wheels are locked to prevent Dolly from slipping.

Double check all parts for alignment and re-tighten all Hex Nuts securely.

#### Warnings:

- Always check stability before using.
- Improper assembly or loose bolts may lead to damage or injury.
- Do not stand or lean on the Dolly.
- Do not overload with more than 800 lbs.
- For use with PDG folding chairs and tables only.

